



LITHIUM IRON PHOSPHATE BATTERY

ELECTRICAL SPECIFICATIONS

Nominal Voltage	12.8 V
Nominal Capacity	100 Ah
Capacity @ 25A	240 min
Energy	1280 Wh
Resistance	≤30 mΩ @ 50% SOC
Efficiency	99%
Self Discharge	<3% per Month
Maximum Modules in Series	6

DISCHARGE SPECIFICATIONS

Maximum Continuous Discharge Current	100 A
Peak Discharge Current	200 A (7.5 s ±2.5 s)
BMS Discharge Current Cut-Off	280 A ±50 A (9 ±4 ms)
Recommended Low Voltage Disconnect	11 V
BMS Discharge Voltage Cut-Off	8 V (2.0 ±0.08 vpc) (140 ±60 ms)
Reconnect Voltage	9.2 V (2.3 ±0.1 vpc)
Short Circuit Protection	200-600 μs

TEMPERATURE SPECIFICATIONS

Discharge Temperature	-4 to 140 °F (-20 to 60 °C)
Charge Temperature	-4 to 113 °F (-20 to 45 °C)
Storage Temperature	23 to 95 °F (-5 to 35 °C)
BMS High Temperature Cut-Off	176 °F (80 °C)
Reconnect Temperature	122 °F (50 °C)

DIMENSIONAL SPECIFICATIONS

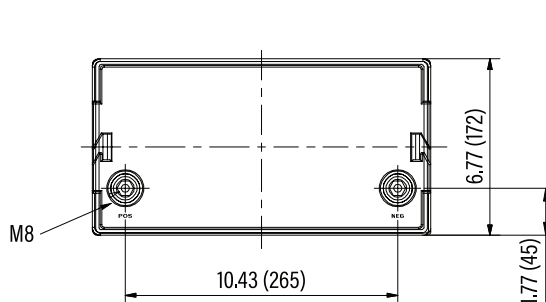

MECHANICAL SPECIFICATIONS

Dimensions (L x W x H)	12.95 x 6.77 x 8.8"
	329 x 172 x 223 mm
Weight	30 lbs (13.5 kg)
Terminal Type	M8
Terminal Torque	80 - 100 in-lbs (9 - 11 N-m)
Case Material	ABS
Enclosure Protection	IP56
Cell Type - Chemistry	Cylindrical - LiFePO ₄

CHARGE SPECIFICATIONS

Recommended Charge Current	5 A - 50 A
Maximum Charge Current	100 A
Charge Current (0 to -10 °C)	≤0.1 C
Charge Current (-20 to -10 °C)	≤0.05 C
Recommended Charge Voltage	14.2 V - 14.6 V
BMS Charge Voltage Cut-Off	15.6 V (3.9 ±0.025 vpc) (1.1 ±0.4 s)
Reconnect Voltage	15.2 V (3.8 ±0.05 vpc)
Balancing Voltage	14.4 V (3.6 ±0.025 vpc)

COMPLIANCE SPECIFICATIONS

Certifications	CE (battery) UN38.3 (battery) UL1642 & IEC62133 (cells)
Shipping Classification	UN 3480, CLASS 9

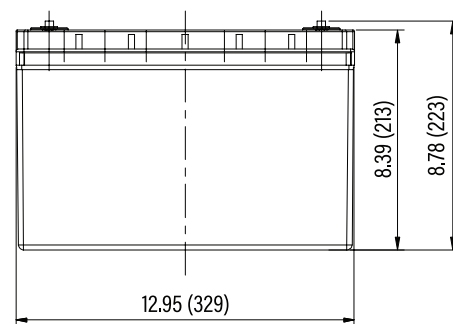



PERFORMANCE CHARACTERISTICS

DISCHARGE VOLTAGE CHARACTERISTICS at VARIOUS RATES
25°C (77°F)

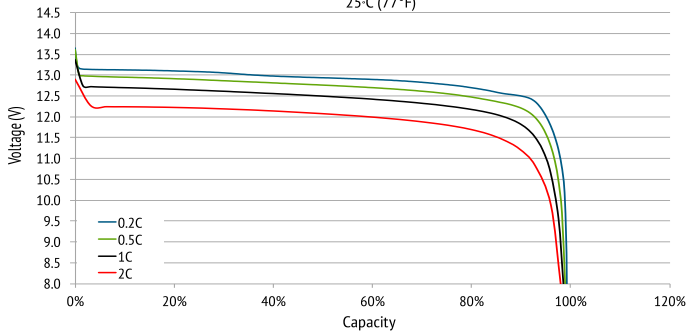

DISCHARGE VOLTAGE CHARACTERISTICS at VARIOUS TEMPERATURES
DISCHARGE 1C

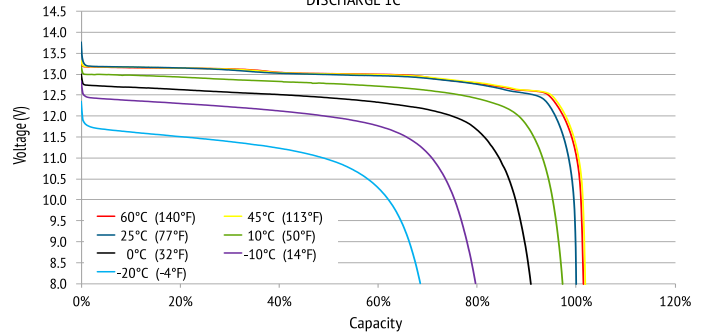

CHARGE VOLTAGE CHARACTERISTICS at VARIOUS TEMPERATURES
CHARGE 0.2C

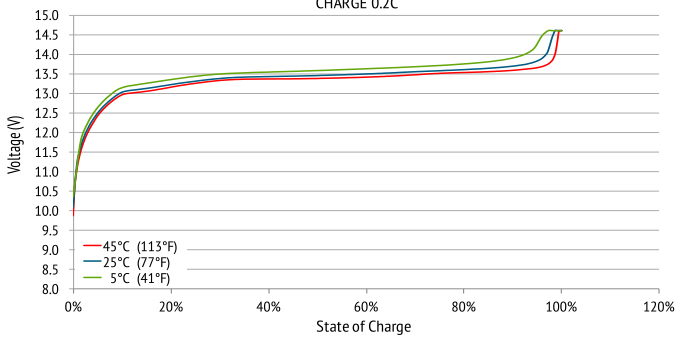

CHARGE VOLTAGE and STATE OF CHARGE (SOC)
CHARGE 0.2C @ 25°C (77°F)

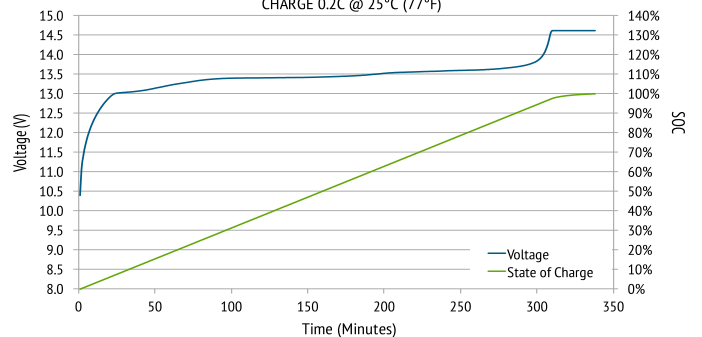

CYCLE LIFE vs. DEPTH OF DISCHARGE (DOD)
DISCHARGE 0.5C/CHARGE 0.5C @ 25°C (77°F)

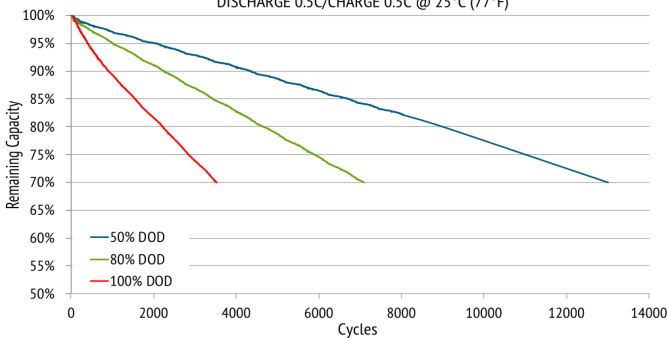

CAPACITY of RELiON LiFePO4 vs. LEAD ACID
at VARIOUS RATES OF DISCHARGE

