

# GREENROCK COMBINER BOX

## INSTALLATION & OPERATION MANUAL

## INDEX

Foreword .....	3
Safety symbols.....	3
Contact information .....	3
Safety.....	4
General .....	4
Environmental conditions.....	4
Qualified personnel .....	5
EMC measures .....	5
Data security.....	5
Copyright .....	5
Scope .....	5
Product Information.....	6
Safety Information.....	6
Electrical Hazards.....	6
Delivery Inspection .....	6
Installation.....	7
Unpacking.....	7
Site Requirements .....	7
Scope of delivery .....	7
Exposure and Enclosure.....	7
Humidity .....	7
Electrical Integration .....	8
Commissioning .....	9
Technical Support.....	10

© 2018 BlueSky Energy

All information in this document is subject to regular updates and changes, corresponding to updates and changes to GREENROCK products. BlueSky Energy new publications and / or related documentation may be created which replace or delete information in this document. Changes and technical improvements may occur at any time without notice.

For the most recent documents, please contact us at [office@bluesky-energy.eu](mailto:office@bluesky-energy.eu)

**All information in this manual was created with great care and tested. However, errors can and sometimes do occur. BlueSky Energy, GmbH assumes no liability for any errors, or consequences resulting from any error.**

## FOREWORD

Thank you for your trust and congratulations on your new, high-quality GREENROCK product. This document will help you to familiarize yourself with the product. By reading this document carefully, you will learn the many features of your GREENROCK product and how to best implement them.

This document serves to document technical information and safeguards for a GREENROCK product. Keep this document as a permanent record near the GREENROCK product and accessible to anyone using the item. Only transfer GREENROCK products to third parties with full documentation package.

The following safety advice must be followed always when using GREENROCK products. Please read the following safety guidelines carefully.

## SAFETY SYMBOLS



### DANGER

Mortal danger if failing to follow



### WARNING

Reference to possible serious injury or death if ignored



### ATTENTION

Recalling the possibility of slight injuries or property damage if ignored



### ACCORDING TO THE DEGREE OF RISK

Recalling electrical risks



### IMPORTANT

Here an important function for the notice is given



### NOTE

General information or particular tips

If you see one of the symbols in the following chapters, carefull attention is required.

## CONTACT INFORMATION

BlueSky Energy  
Fornacherstraße 12  
4870 Vöcklamarkt  
austria  
Tel .: +43720 01 01 88  
[www.bluesky-energy.eu](http://www.bluesky-energy.eu)  
[office@bluesky-energy.eu](mailto:office@bluesky-energy.eu)

# SAFETY

## General

The product is manufactured according to the strict process controls and incorporates recognized safety standards. However, incorrect operation or misuse may endanger:

- Life and limb of the operator or third parties
- the device and other properties of the operator
- the efficient operation of the device

All those involved in the commissioning, servicing and maintenance of the product must

- be appropriately qualified
- have knowledge of electrical installations and
- read and follow these instructions completely and carefully

The documentation must be kept permanently at your product. In addition to the documentation, the generally applicable and local regulations regarding accident prevention and environmental protection must be observed.

All safety instructions and warnings on the product should:

- be kept in legible condition
- be not damaged
- not be removed
- not be covered, pasted or painted over

The terminals can reach high temperatures.

Only operate the product when all protective devices are fully functional. If safety equipment is not fully functional, there is a risk to:

- Life and limb of the operator or third parties
- the device and other properties of the operator
- the efficient operation of the product

After repair by authorized dealer, insure that all safety devices are fully functioning before using product again.

Never bypass or decommission.

Errors or malfunctions that may affect safety must be remedied before activating the product.

**It's all about your safety!**

## Environmental conditions

Operation or storage of the product outside the stipulated range is not recommended and may cause serious damage to product or installation. The manufacturer is not liable for any damage suffered.

Refer to the specifications of your GREENROCK product for information regarding the permissible storage & operating temperature conditions.

## Qualified personnel

The information in this document is intended only for qualified personnel. An electrical shock may be fatal. Do not perform any activities other than those listed in the documentation.

All cables and wires must be secured, undamaged, insulated and adequately dimensioned. If you find any loose connections, scorched, damaged or undersized wires or cables, have item immediately reviewed by an authorized dealer/repair specialist.

Maintenance and repair should only be performed by an authorized dealer.

Unauthorized parts from non-approved external suppliers are not guaranteed to meet load and safety requirements. Only use original and authorized spare parts (also applies to standard parts).

Do not make any alterations, installations or modifications to the product without approval of the manufacturer.

Replace components if not perfect condition immediately.

## EMC measures

In some cases, EM signals from this product may interfere with certain nearby devices, despite maintaining standardized emission designs (e.g. when certain sensitive equipment is at the site or if the site is near a radio or television receivers). In this case, the operator is obliged to take appropriate measures for troubleshooting.

## Data security

User is responsible for data backup when changes are made to factory settings. If personal settings are deleted, the manufacturer is not liable.

## Copyright

The copyright of this document remains with the manufacturer.

The information contained in this document are the property of BlueSky Energy GmbH. Further publication, in whole or in part, requires the written consent of BlueSky Energy GmbH. An internal duplication, which is intended for evaluation of the product or to the proper use is allowed and does not require authorization.

Text and illustrations are deemed technically correct at publication but are subject to change. The content of the documentation does not justify any claims by the purchaser. Suggestions for improvements and information regarding errors in the documentation are welcomed.

Operating instructions, manuals and software are protected by copyright. Copying, duplication, translation, conversion into any electronic medium or machine-readable form in whole or in part is permitted only with explicit approval of BlueSky Energy GmbH. An exception is represented by creation of a backup copy of the software for backup purposes for their own use. Violators will be prosecuted and liable for damages. All trademarks or trademarks used in this document only indicate that product or the owner of the trademark or brand. The naming of products which are not that of BlueSky Energy GmbH are for informational purposes only.

## Scope

This document applies to the following products:

- GREENROCK Combiner Box

## PRODUCT INFORMATION

This manual is intended to provide technical information and safe practices regarding receiving, installing, and operating the GREENROCK Combiner Box.



### **DANGER**

Failure to follow the instructions in this document could result in fire, electric shock, and/or other injury or damage.

## SAFETY INFORMATION

Only qualified individuals are allowed to install and service battery systems.

### Electrical Hazards

Never place foreign objects or tools in or on the unit. The metal parts of the battery terminals are always live. Electrical hazards exist in the voltage and current ranges that are found in battery systems and associated electronics.



### **DANGER**

Connecting Saltwater batteries in series can lead to dangerously high voltages. BlueSky must review any series configurations of Saltwater batteries prior to installation. Never connect Saltwater 24V-Stack or 48V-Stacks batteries in series. When connecting Saltwater batteries in parallel, BlueSky recommends placing overcurrent protection devices as close as possible to the DC bus.

The metal parts of the battery terminals are always live. Never place foreign objects or tools in or on the unit. Arcing or fusing could result.

Battery itself has no fuses built in. Never short-circuit the battery terminals. High currents will cause which can damage the battery

### Delivery Inspection

If you find damage, document it on the bill of lading before accepting the shipment. Separately document and photograph all damage and make a claim with the carrier immediately. Contact your distributor immediately.

## INSTALLATION



### ATTENTION

Saltwater batteries ship at low state of charge and low voltage

## Unpacking

Unpack all items carefully and note quantities received. Contact your authorized GREENROCK distributor if any items are missing or damaged.

## Site Requirements

- Indoors or enclosed
- Dry, clean, ordinary conditions
- Ambient temperature between -5°C and +50°C
- Surface capable of bearing product weight
- Product out of direct sunlight

## Scope of delivery

- Combiner Box
- Router
- Patch Cable
- Temperature Sensor
- 12 Fuses
- 6 Screws for Inverter Cables

Make sure that all components listed above are included.





## Exposure and Enclosure

The GREENROCK Combiner Box should be installed indoors or enclosed from the elements. A fully sealed enclosure is not recommended.



## Humidity

Install the GREENROCK Combiner Box in clean, ordinary conditions protected from water exposure. Direct exposure of the GREENROCK Combiner Box to water may cause shorting. The GREENROCK Combiner Box may be installed in humid or coastal regions with atmospheric salt.

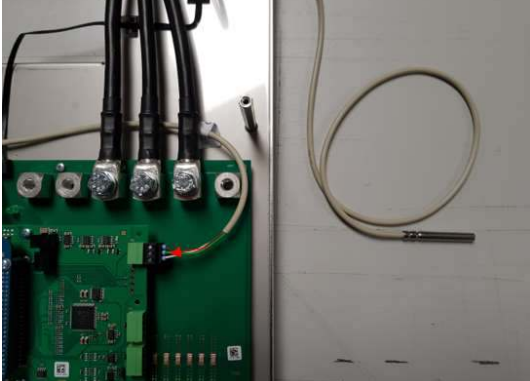
## ELECTRICAL INTEGRATION

<ul style="list-style-type: none"> <li>remove the six screws on the upper side of the combiner box</li> <li>open the Combiner Box</li>   <li>make sure the inverters are turned off</li> <li>make sure that the AC breaker between Inverters and grid are open</li> <li>make sure that there is no voltage on the Inverter DC terminals</li> </ul>	
<ul style="list-style-type: none"> <li>the battery stacks can be connected one by one</li> <li>First connect the battery (+) cable to the to the first connector on the (+) side of the combiner board</li> <li>Connect the corresponding (-) cable of the battery to the first connector on the (-) side of the combiner board</li> <li>connect the rest of the batteries in the same way</li> </ul>	
<ul style="list-style-type: none"> <li>please mark the batteries with a number corresponding to the connector number in which the battery is connected. (Starting with 1 up to 12)</li> </ul>	
<ul style="list-style-type: none"> <li>After connecting the batteries, the inverter(s) can be connected.</li> <li>In Order to do that the right DC Cables are needed. The Inverter cables are not in the scope of delivery of the combiner box. For Victron Inverters the cables can be delivered by BlueSky Energy.</li> <li>For other Inverters the DC Cable must be provided by the installer</li> </ul>	
<ul style="list-style-type: none"> <li>The Inverter cables must be mounted with a torque of 9Nm.</li> </ul>	
<ul style="list-style-type: none"> <li>Connect the delivered temperature sensor to the Combiner Board</li> </ul>	



<ul style="list-style-type: none"> <li>▪ Connect the router to the Internet via the wan-port</li> </ul>	
<ul style="list-style-type: none"> <li>▪ Connect the provided patch cable to any free port of the router</li> <li>▪ If you use a Victron System, the CCGX or the Venus Beagle Bone must also be connected to the router</li> </ul>	
<ul style="list-style-type: none"> <li>▪ Connect the other end of the cable to the combiner box</li> </ul>	
<p>The Router is preconfigured there is no additional configuration or setup necessary. As soon as the router is connected to the internet and the combiner box is turned on the combiner box will automatically establish a connection to our server.</p>	

## COMMISSIONING

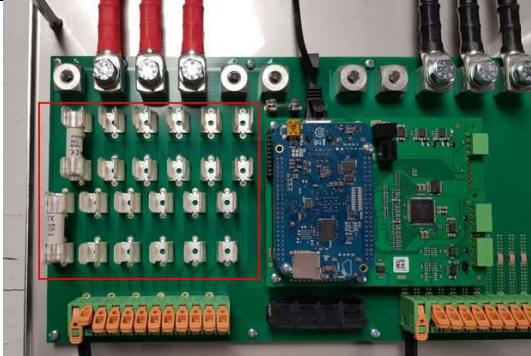
<ul style="list-style-type: none"> <li>▪ when everything is setup properly the delivered fuses can be inserted into the combiner board</li> <li>▪ insert one fuse for each connected battery stack.</li> <li>▪ when inserting the first fuse the capacitors of the inverters will be charged, this leads to a small arc through the fuse.</li> </ul>	
<p>After inserting the fuses, the Combiner Box is ready to go. The Inverters can now be powered up. The system should start-up and will continue operation. On Victron installations the Combiner Box will now send the more accurate estimated SOC to the System. After first Startup the SOC value will be near zero. The SOC has to be recalibrated when the battery is empty. This will be done automatically at the next full discharge.</p>	

## TECHNICAL SUPPORT

If you need technical support, visit us on our website at <http://bluesky-energy.eu>

If you purchased your GREENROCK Combiner Box from an authorized GREENROCK partner, please contact the partner for assistance. If you require immediate assistance AND if you purchased your products directly from BlueSky-Energy, call our support line at +43 720 01 01 88. Please have your BlueSky Energy order number ready.